

CPU

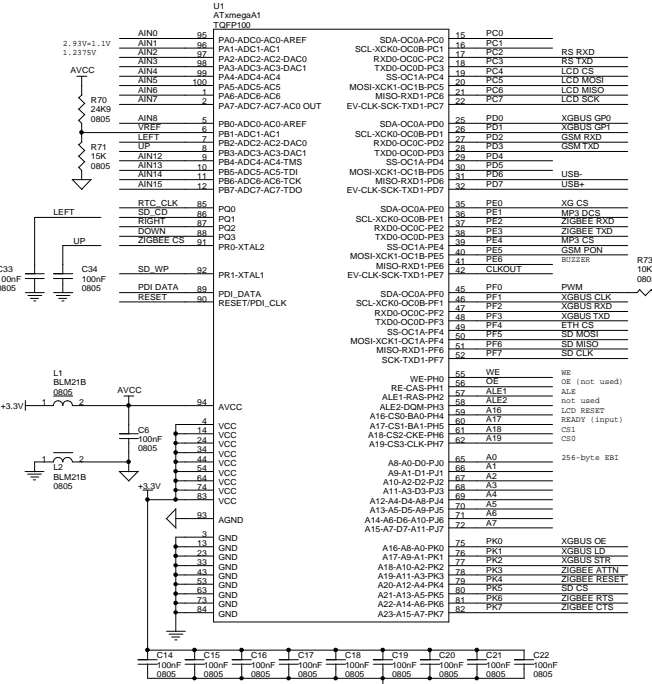

ZIGBEE

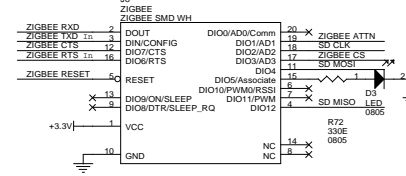

LCD CONTROLLER

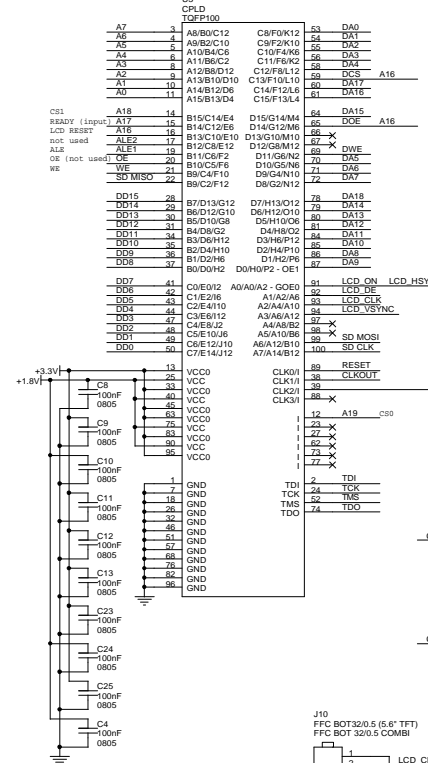

LCD CONTROLLER

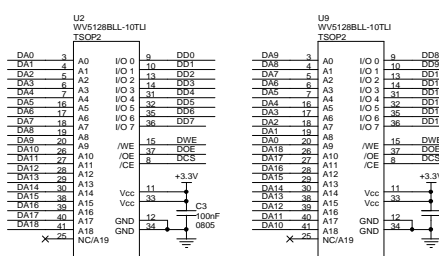

SDCARD

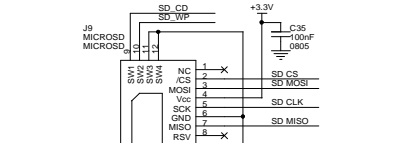

SDCARD

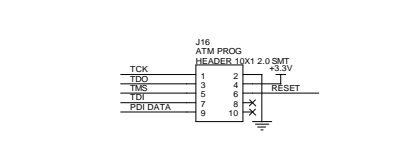

SDCARD

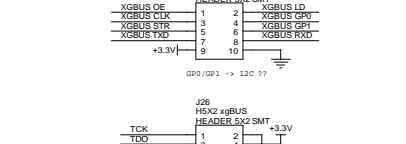

USB POWER SUPPLY

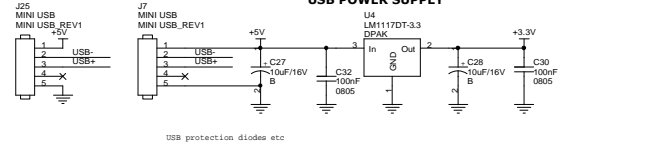

SDCARD

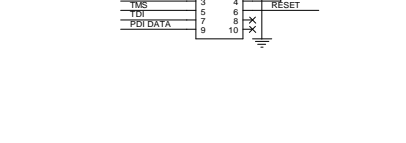

XG7100 EXPANSION HEADERS

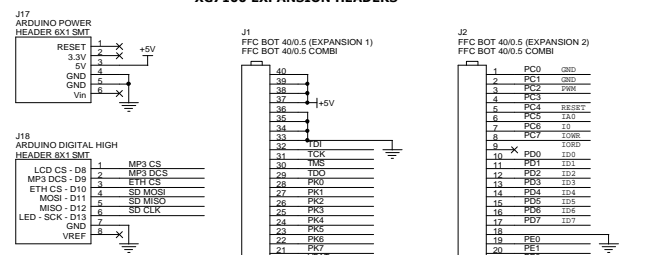

XG7000 EXPANSION HEADERS

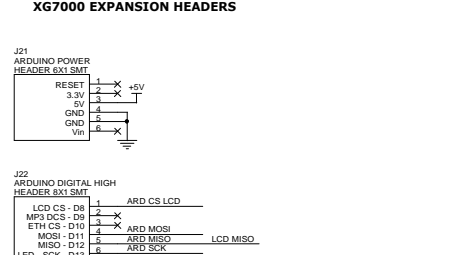

LCD CONNECTORS

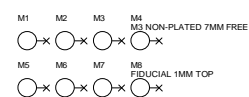
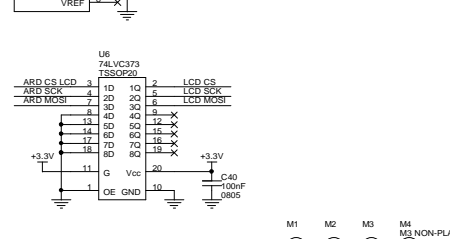
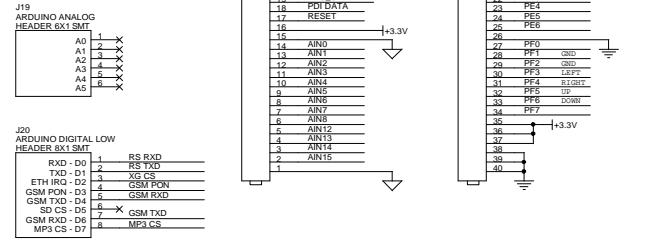
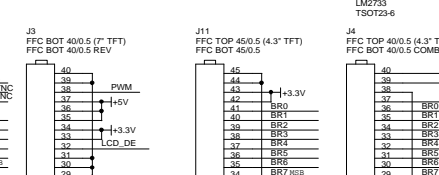
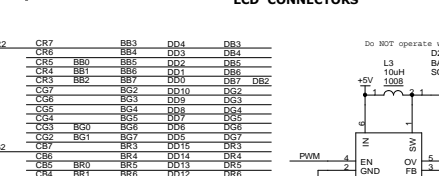

Table with 4 columns: Size (A2), CAGE Code, DWG NO (XG7100-R3), Rev (1). Includes title block information like X-GRAPH, Technoloogien 3 B-3001 Leuven, and date Monday, April 16, 2012.